

White High-Intensity LED Lamp (3 mm, 45° Viewing Angle)

OVLAW4CB7

- High luminous intensity
- Through-hole type
- Water clear lens
- Available on tape and reel



The **OVLAW4CB7** is a round 3mm white high-intensity through-hole lamp with a 45° viewing angle. It is designed for wide-angle uniform light output.

Applications

- Indicators for medical, industrial, consumer and office equipment
- Indicators for white goods and home appliances
- Interior and exterior architectural and accent lighting
- Signs and digital information displays, video screen non-color and RGB presentation
- Automotive backlighting and indicators

Part Number	Material	Emitted Color	Intensity Typ. mcd	Lens Color
OVLAW4CB7	InGaN	White	3500	Water Clear

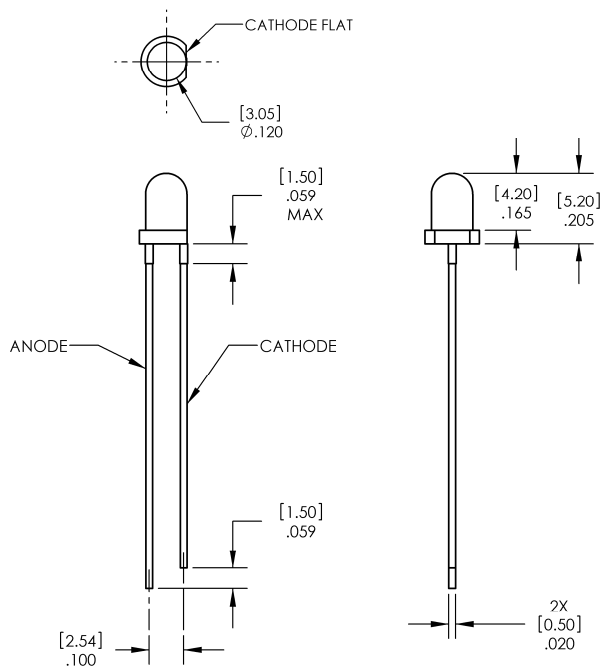

NOTES:

1. DIMENSIONS ARE IN INCHES [MM].
2. TOLERANCE IS $\pm .008$ [.20] UNLESS OTHERWISE SPECIFIED.
3. PROTRUDED RESIN UNDER FLANGE IS .059 [1.5] MAX.
4. LEADSPACING IS MEASURED WHERE THE LEADS EMERGE FROM THE PACKAGE.

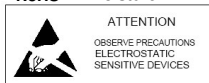

DO NOT LOOK DIRECTLY AT LED WITH UNSHIELDED EYES OR DAMAGE TO RETINA MAY OCCUR.

OPTEK reserves the right to make changes at any time in order to improve design and to supply the best product possible.

White High-Intensity LED Lamp

OVLAW4CB7



Absolute Maximum Ratings

$T_A = 25^\circ\text{C}$ unless otherwise noted

Storage Temperature Range	-40 ~ +100° C
Operating Temperature Range	-40 ~ +85° C
Reverse Voltage	5 V
Power Dissipation	80 mW
Average Forward Current	20 mA
Peak Forward Current (Duty Ratio = 1/10, Pulse Width =0.1ms)	50mA
Current Linearity vs Ambient Temperature	-0.2 mA/° C
LED Junction Temperature	125° C
Lead Soldering Temperature (5 seconds maximum)	260° C

Electrical and Optical Characteristics

$T_A = 25^\circ\text{C}$ unless otherwise noted

SYMBOL	PARAMETER	MIN	TYP	MAX	UNITS	CONDITIONS
I_V	Luminous Intensity	2225	3500	6105	mcd	$I_F = 20\text{ mA}$
$2\theta_{1/2}$	50% Power Angle	----	45	----	deg	$I_F = 20\text{ mA}$
V_F	Forward Voltage	2.6	3.4	4.0	V	$I_F = 20\text{ mA}$
I_R	Reverse Current	----	----	50	μA	$V_R = 5\text{ V}$
x	Chromaticity Coordinates	----	0.31	----	----	$I_F = 20\text{ mA}$
y		----	0.32	----	----	$I_F = 20\text{ mA}$

Standard Bins ($I_F = 20\text{ mA}$)

Lamps are sorted to luminous intensity (I_V) and chromaticity coordinates (x,y) bins shown. Orders for OVLAW4CB7 may be filled with any or all bins contained as below.

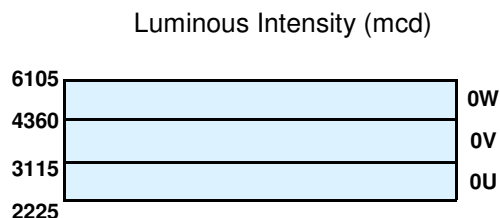

Notes:

- All ranks will be included per delivery, rank ratio will be based on the chip distribution.
- To designate luminous intensity ranks, please contact OPTEK.
- Pb content <1000 PPM.
- Part is sensitive to static electricity and precautions must be used when handling products.

OPTEK reserves the right to make changes at any time in order to improve design and to supply the best product possible.

White High-Intensity LED Lamp

OVLAW4CB7



Chromaticity Coordinates for White Bin Structure

Bin					
A1	Cx	0.25	0.26	0.26	0.25
	Cy	0.165	0.18	0.223	0.208
A2	Cx	0.25	0.26	0.26	0.25
	Cy	0.208	0.223	0.265	0.25
B1	Cx	0.26	0.27	0.27	0.26
	Cy	0.18	0.195	0.238	0.223
B2	Cx	0.26	0.27	0.27	0.26
	Cy	0.223	0.238	0.28	0.265
C1	Cx	0.27	0.28	0.28	0.27
	Cy	0.195	0.21	0.253	0.238
C2	Cx	0.27	0.28	0.28	0.27
	Cy	0.238	0.253	0.295	0.28
D1	Cx	0.28	0.29	0.29	0.28
	Cy	0.21	0.225	0.268	0.253
D2	Cx	0.28	0.29	0.29	0.28
	Cy	0.253	0.268	0.31	0.295
E1	Cx	0.29	0.3	0.3	0.29
	Cy	0.225	0.24	0.283	0.268
E2	Cx	0.29	0.3	0.3	0.29
	Cy	0.268	0.283	0.325	0.31
F1	Cx	0.3	0.31	0.31	0.3
	Cy	0.24	0.255	0.298	0.283
F2	Cx	0.3	0.31	0.31	0.3
	Cy	0.283	0.298	0.34	0.325
G1	Cx	0.31	0.32	0.32	0.31
	Cy	0.255	0.27	0.313	0.298
G2	Cx	0.31	0.32	0.32	0.31
	Cy	0.298	0.313	0.355	0.34
H1	Cx	0.32	0.33	0.33	0.32
	Cy	0.27	0.285	0.328	0.313
H2	Cx	0.32	0.33	0.33	0.32
	Cy	0.313	0.328	0.37	0.355
J1	Cx	0.33	0.34	0.34	0.33
	Cy	0.285	0.3	0.343	0.328
J2	Cx	0.33	0.34	0.34	0.33
	Cy	0.328	0.343	0.385	0.37
K1	Cx	0.34	0.35	0.35	0.34
	Cy	0.3	0.315	0.358	0.343
K2	Cx	0.34	0.35	0.35	0.34
	Cy	0.343	0.358	0.4	0.385

OPTEK reserves the right to make changes at any time in order to improve design and to supply the best product possible.

CIE Chromaticity Diagram

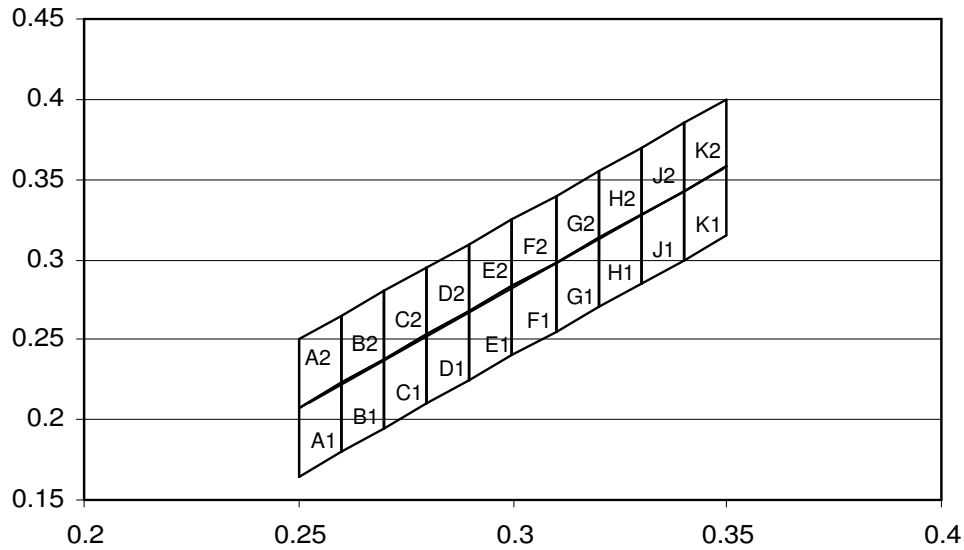

Beam Pattern

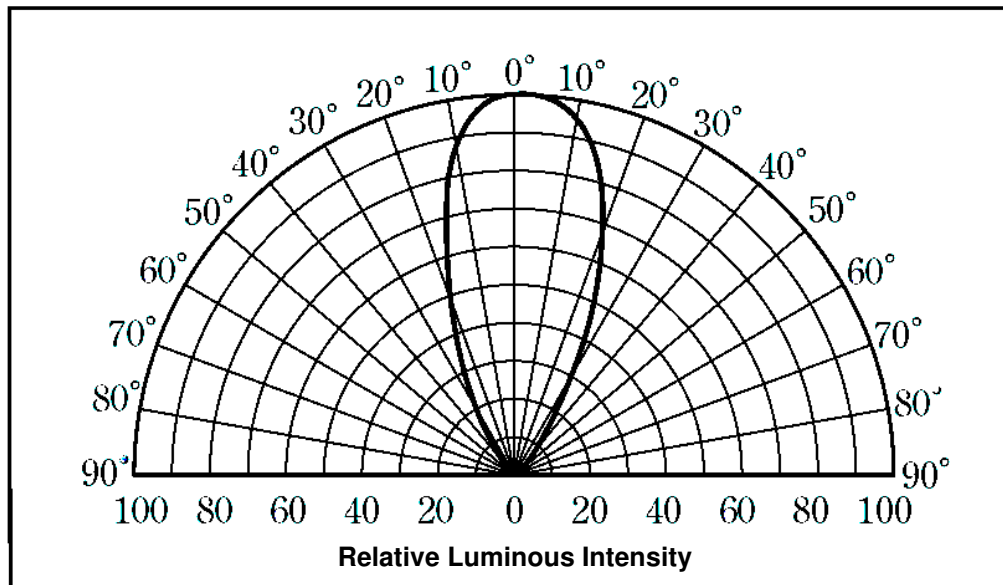

OPTEK reserves the right to make changes at any time in order to improve design and to supply the best product possible.

Typical Electro-Optical Characteristics Curves

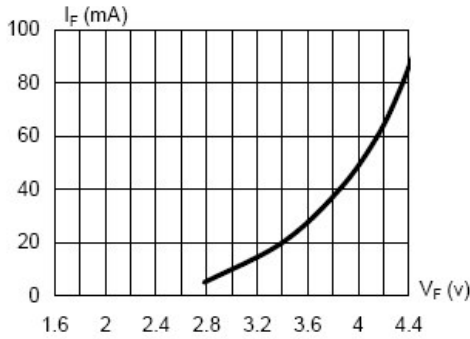

Fig.1 Forward Current vs. Forward Voltage

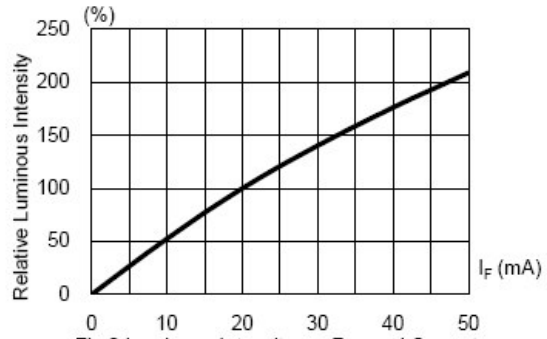

Fig.2 Luminous Intensity vs. Forward Current

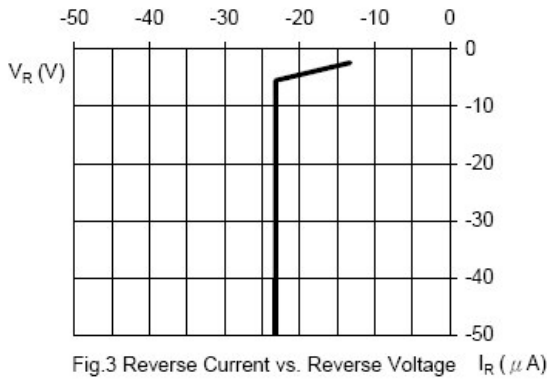

Fig.3 Reverse Current vs. Reverse Voltage

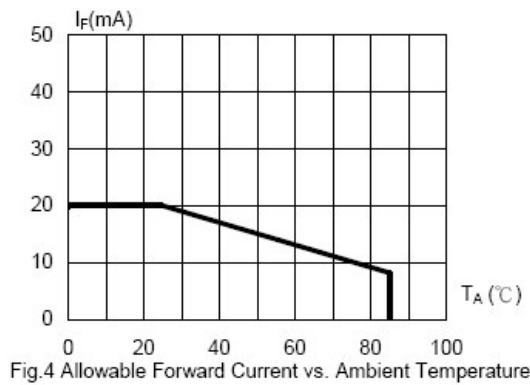

Fig.4 Allowable Forward Current vs. Ambient Temperature

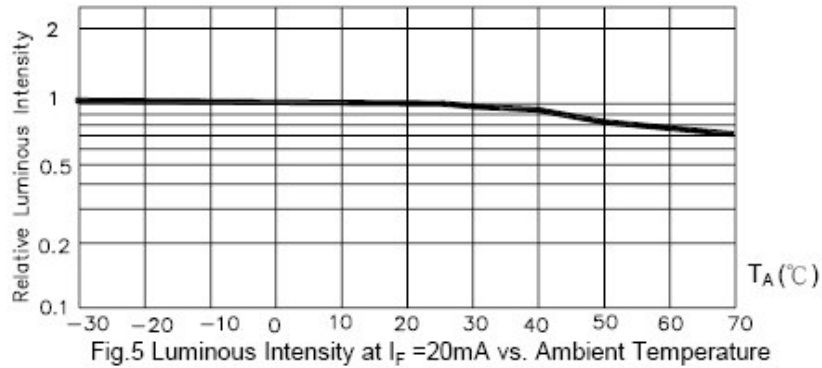

Fig.5 Luminous Intensity at $I_F = 20mA$ vs. Ambient Temperature

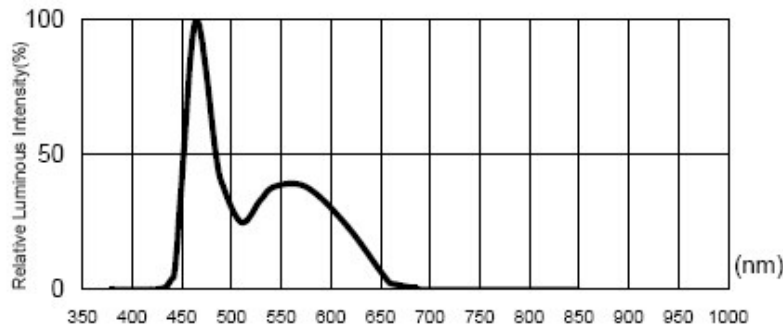

Fig.6. Relative Luminous Intensity vs. Wavelength

OPTEK reserves the right to make changes at any time in order to improve design and to supply the best product possible.

White High-Intensity LED Lamp

OVLAW4CB7



Reliability Test

LED lamps are checked by reliability tests based on MIL standards.

1. Test Conditions, Acceptable Criteria & Results

Classification	Test Item	Standard Test Method	Test Conditions	Duration	Unit	Acc / Rej Criteria	Result
Life Test	Operation Life Test (OLT)	MIL-STD-750D Method 1026.3	$T_A=25^{\circ}\text{C}$, $I_F=30\text{mA}$ *	1000 Hrs	100	0 / 1	Pass
Environment Test	High Temperature Storage (HTS)	MIL-STD-750D Method 1032.1	$T_A=100^{\circ}\text{C}$	1000 Hrs	100	0 / 1	Pass
	Low Temperature Storage (LTS)	MIL-STD-750D Method 1032.1	$T_A=-40^{\circ}\text{C}$	1000 Hrs	100	0 / 1	Pass
	Temp. & Humidity with Bias (THB)	MIL-STD-750D Method 103B	$T_A=85^{\circ}\text{C}$, Rh=85% $I_F=20\text{mA}$ **	500 Hrs	100	0 / 1	Pass
	Thermal Shock Test (TST)	MIL-STD-750D Method 1056.1	$0^{\circ}\text{C} \sim 100^{\circ}\text{C}$ 2min 2min	100 cycles	100	0 / 1	Pass
	Temperature Cycling Test (TCT)	MIL-STD-750D Method 1051.5	$-40^{\circ}\text{C} \sim 25^{\circ}\text{C} \sim 100^{\circ}\text{C} \sim 25^{\circ}\text{C}$ 30min 5min 30min 5min	100 cycles	100	0 / 1	Pass
Mechanical Test	Solderability	MIL-STD-750D Method 2026.4	$235\pm 5^{\circ}\text{C}$, 5 sec	1 time	20	0 / 1	Pass
	Resistance to Soldering Heat	MIL-STD-750D Method 2031.1	$260\pm 5^{\circ}\text{C}$, 10 sec	1 time	20	0 / 1	Pass
	Lead Integrity	MIL-STD-750D Method 2036.3	Load 2.5N (0.25kgf) $0^{\circ} \sim 90^{\circ} \sim 0^{\circ}$, bend	3 times	20	0 / 1	Pass

Remark : (*) $I_F=30\text{mA}$ for AlInGaP chip ; $I_F=20\text{mA}$ for InGaN chip

(**) $I_F=20\text{mA}$ for AlInGaP chip ; $I_F=10\text{mA}$ for InGaN chip

2. Failure Criteria ($T_A = 25^{\circ}\text{C}$):

Test Item	Symbol	Test Conditions	Criteria for Judgment	
			Min.	Max.
Luminous Intensity	I_V	$I_F=20\text{mA}$	$\text{LSL} \times 0.7$ **	
Voltage (Forward)	V_F	$I_F=20\text{mA}$		$\text{USL} \times 1.1$ *

(*) USL : Upper Standard Level , (**) LSL : Lower Standard Level

OPTEK reserves the right to make changes at any time in order to improve design and to supply the best product possible.

White High-Intensity LED Lamp

OVLAW4CB7



Packing Information: Available in bulk or reel

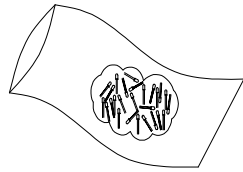

Bulk: 500 pcs
Anti-static/Anti-corrosion bag

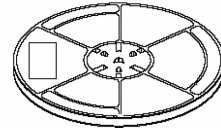

13-Inch Reel: 2000 pcs/reel

Carrier Tape Dimensions: Loaded quantity 2000 pieces per reel

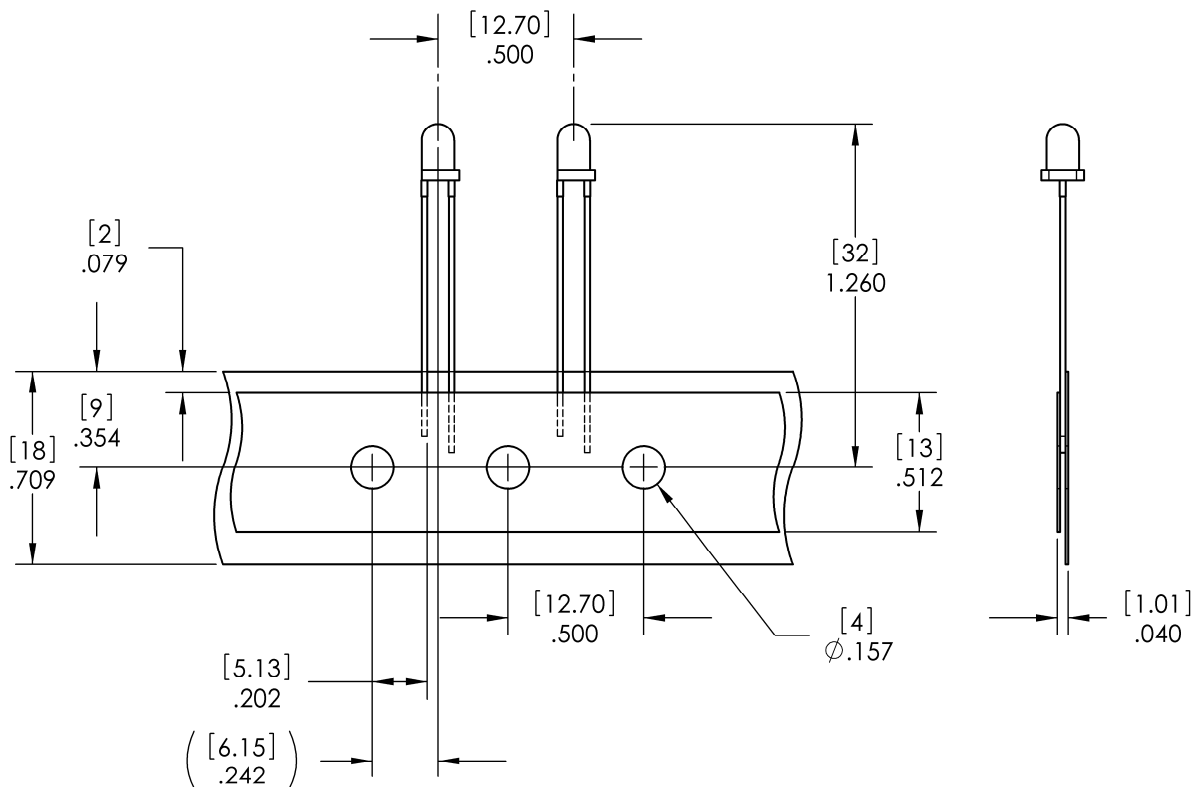

Moisture Resistant Packaging

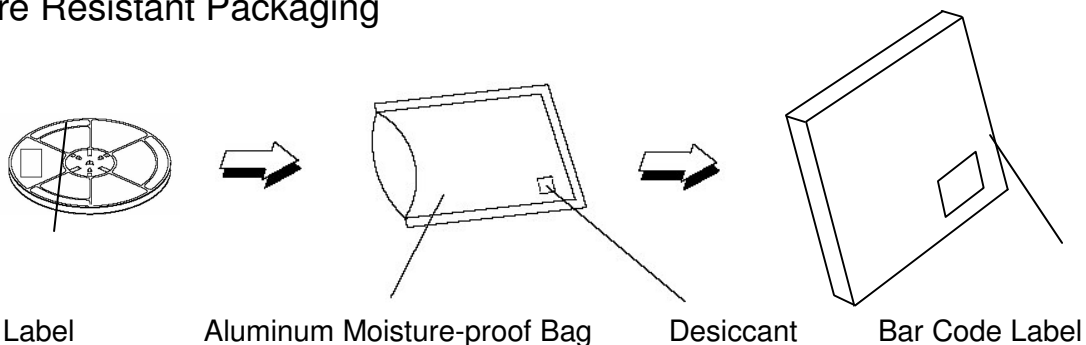

OPTEK reserves the right to make changes at any time in order to improve design and to supply the best product possible.

Recommended Sn-Pb IR-Reflow Soldering Profile

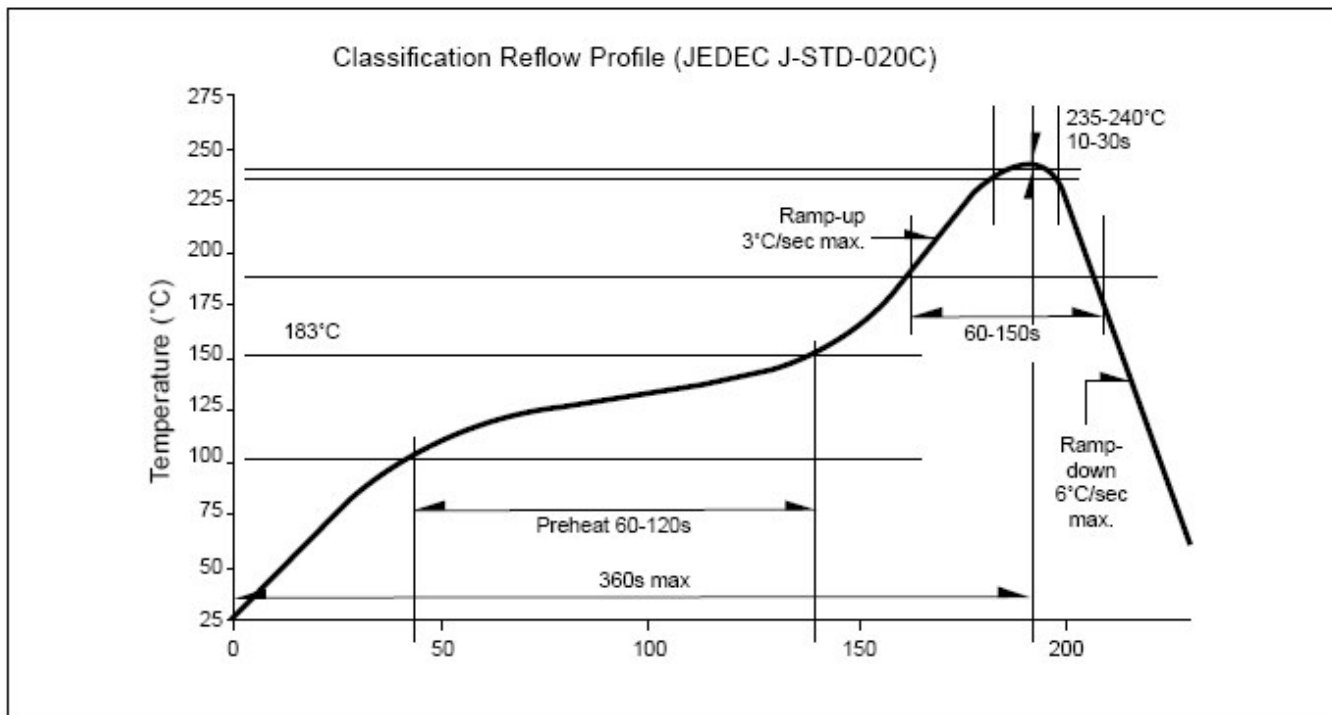

Recommended Pb-free Soldering Profile

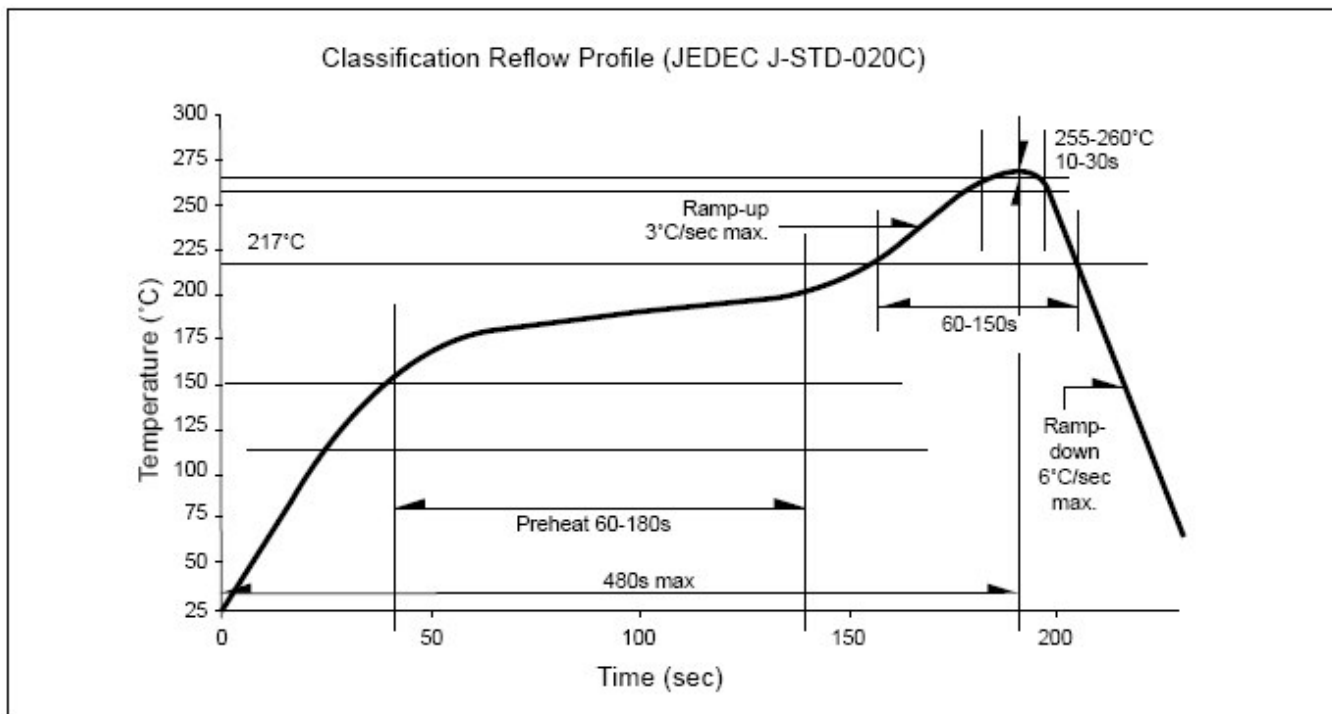

OPTEK reserves the right to make changes at any time in order to improve design and to supply the best product possible.